

Crystal Equipped

Model:2033W8 W8"H18"E4" L4

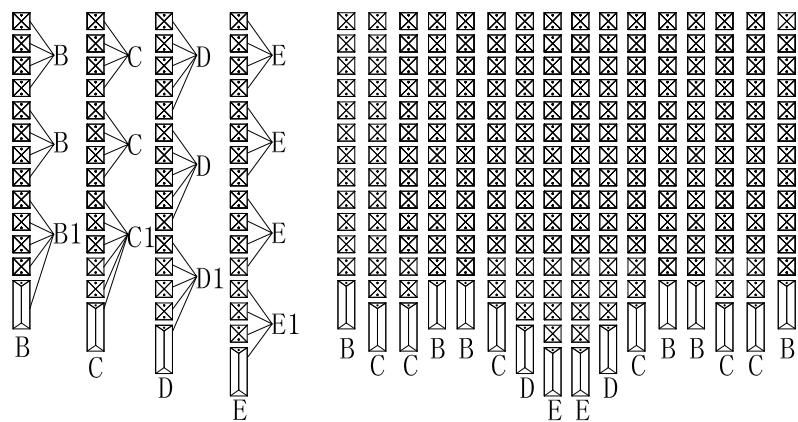
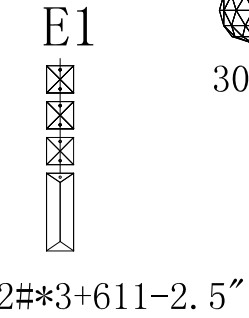
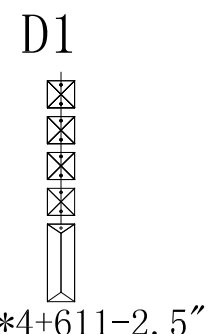
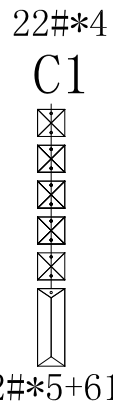
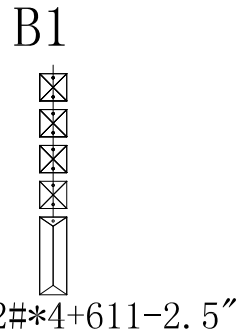
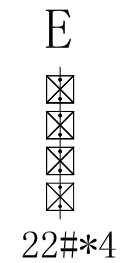
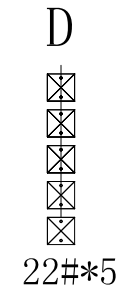
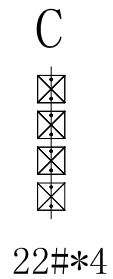
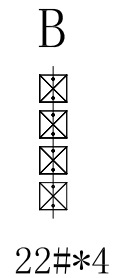
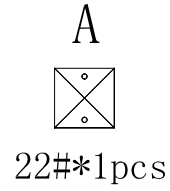
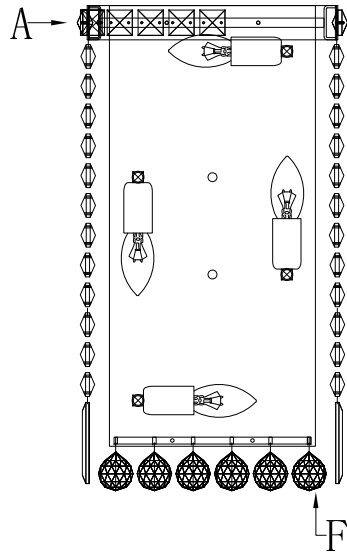

No	Quantity
A	16string
B	12string
B1	6string
C	12string
C1	6string
D	4string
D1	2string
E	6string
E1	2string
F	18string

WARNING! RISK OF FIRE OR ELECTRICAL SHOCK. THIS PRODUCT MUST BE INSTALLED BY A QUALIFIED ELECTRICIAN ONLY